

Proefsleuf 1 en 38

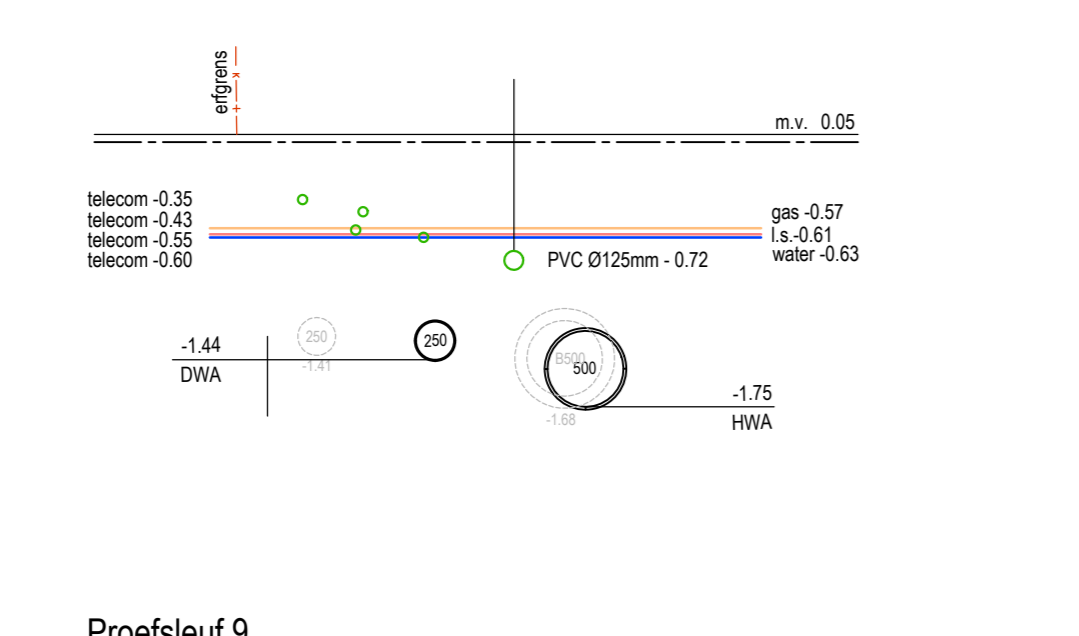

Proefsleuf 9

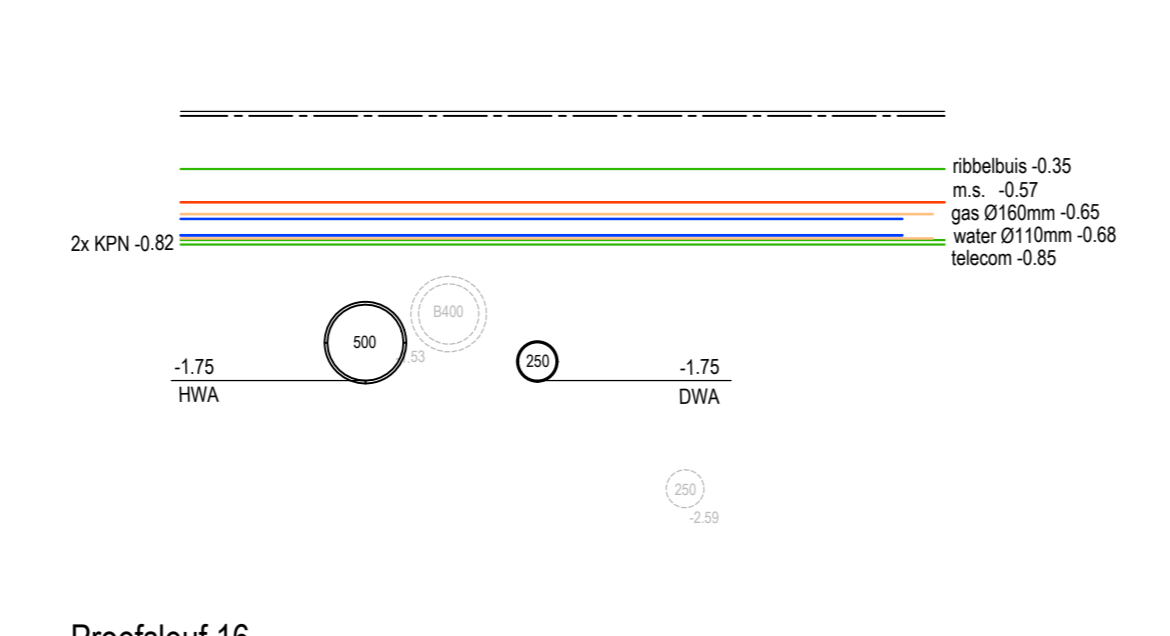

Proefsleuf 16

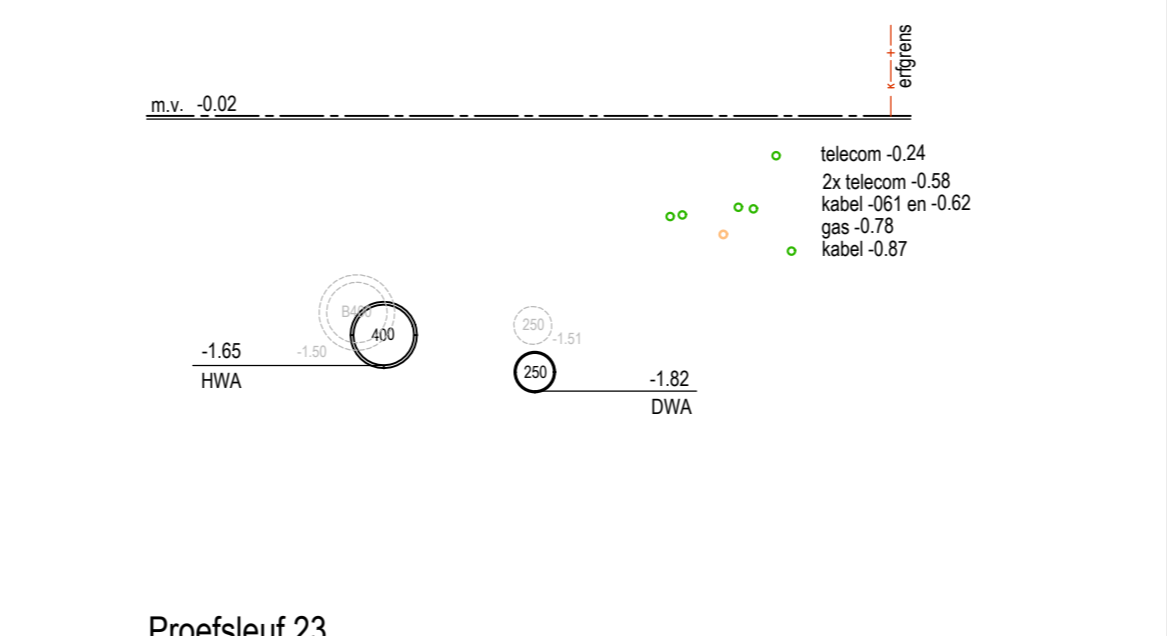

Proefsleuf 23

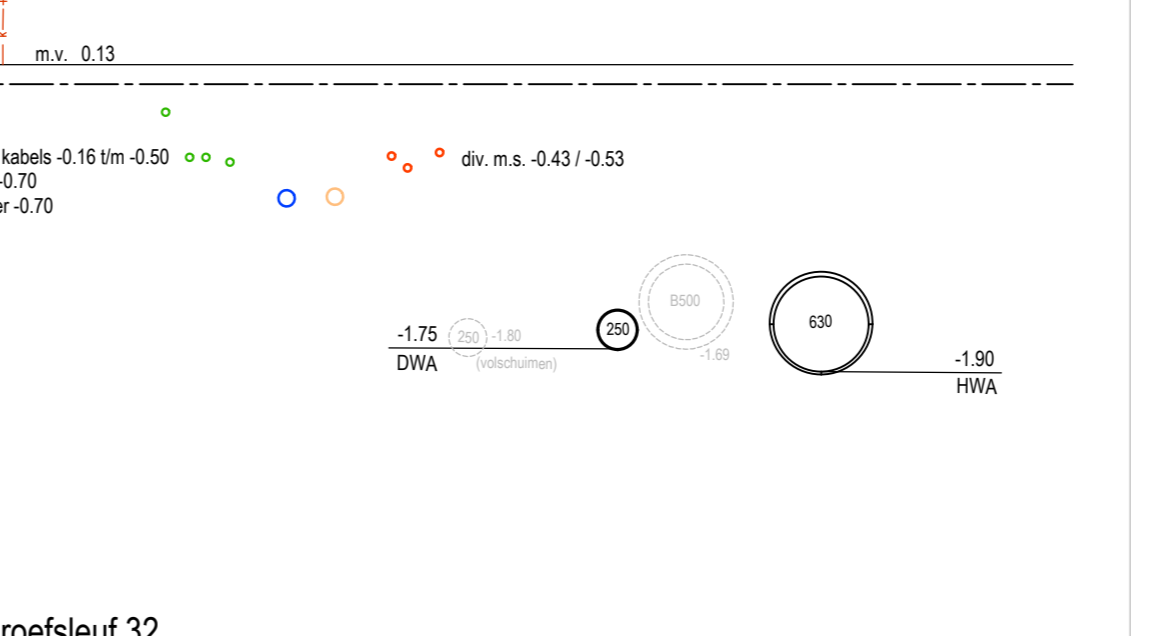

Proefsleuf 32

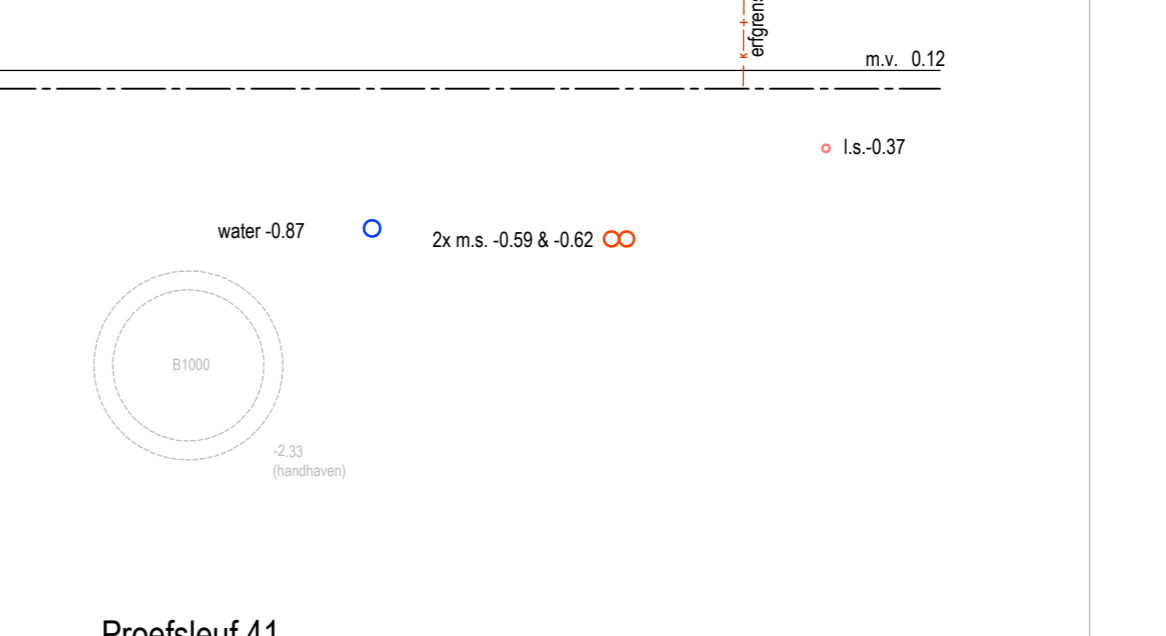

Proefsleuf 41

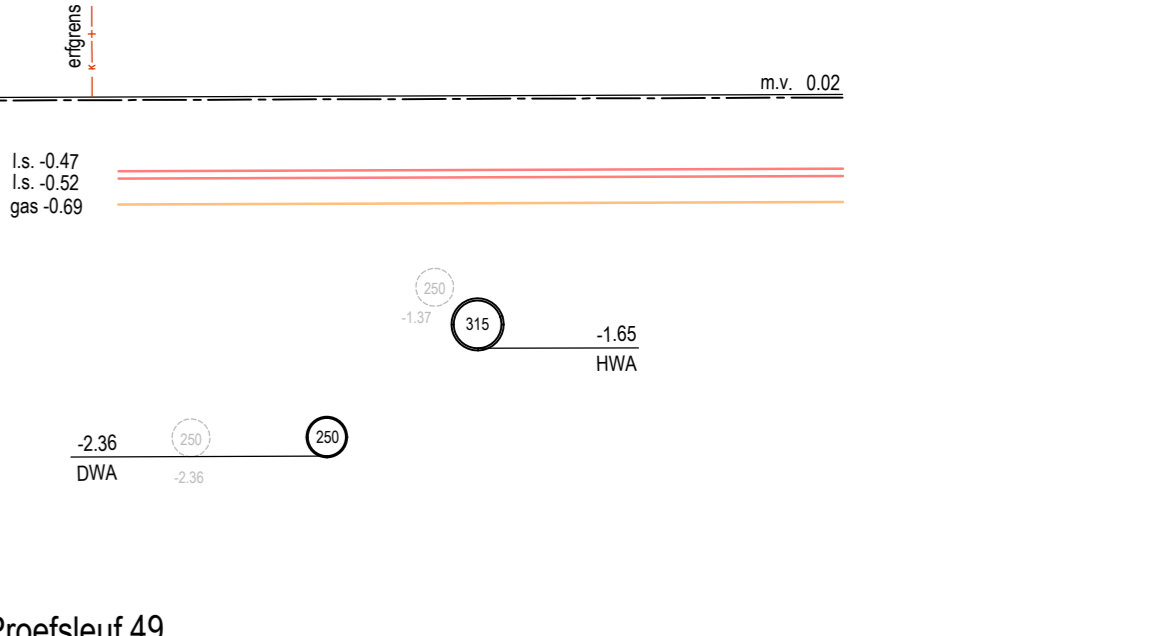

Proefsleuf 49

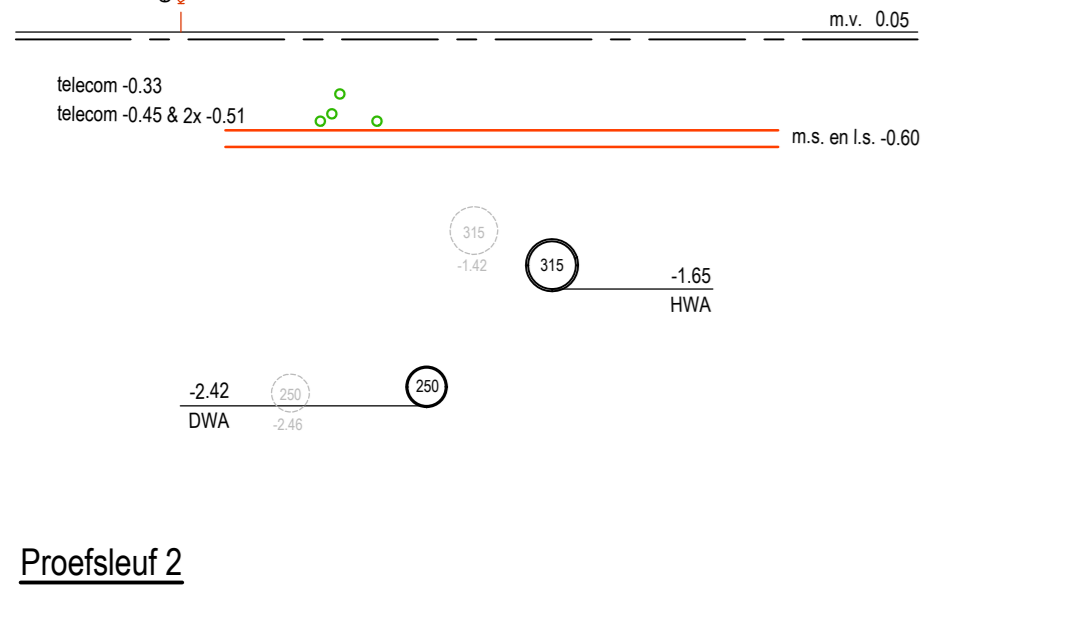

Proefsleuf 2

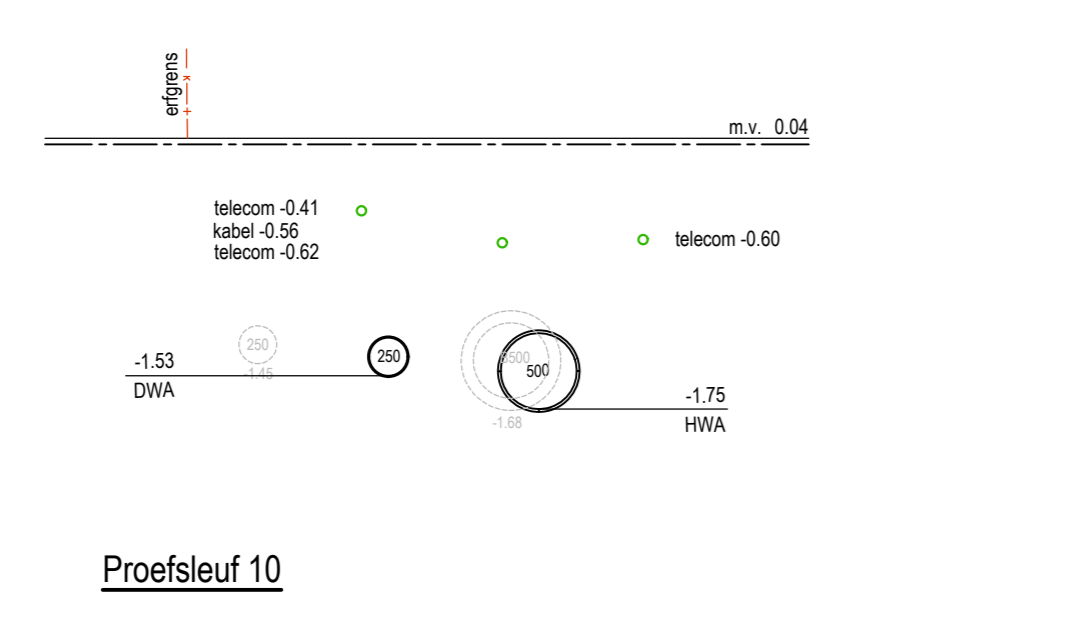

Proefsleuf 10

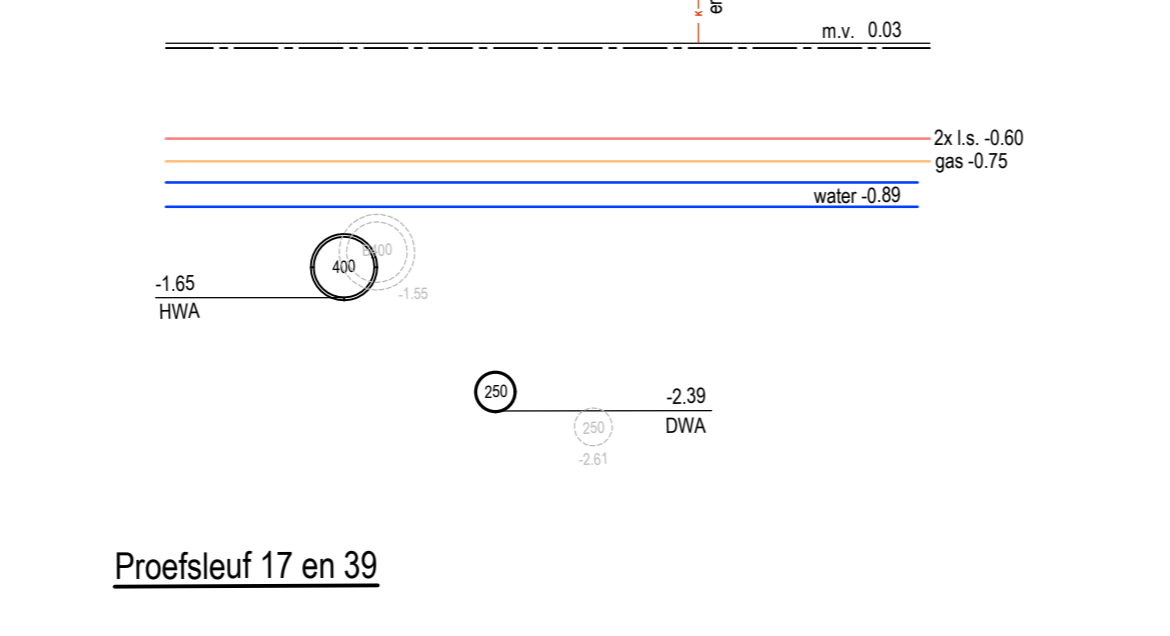

Proefsleuf 17 en 39

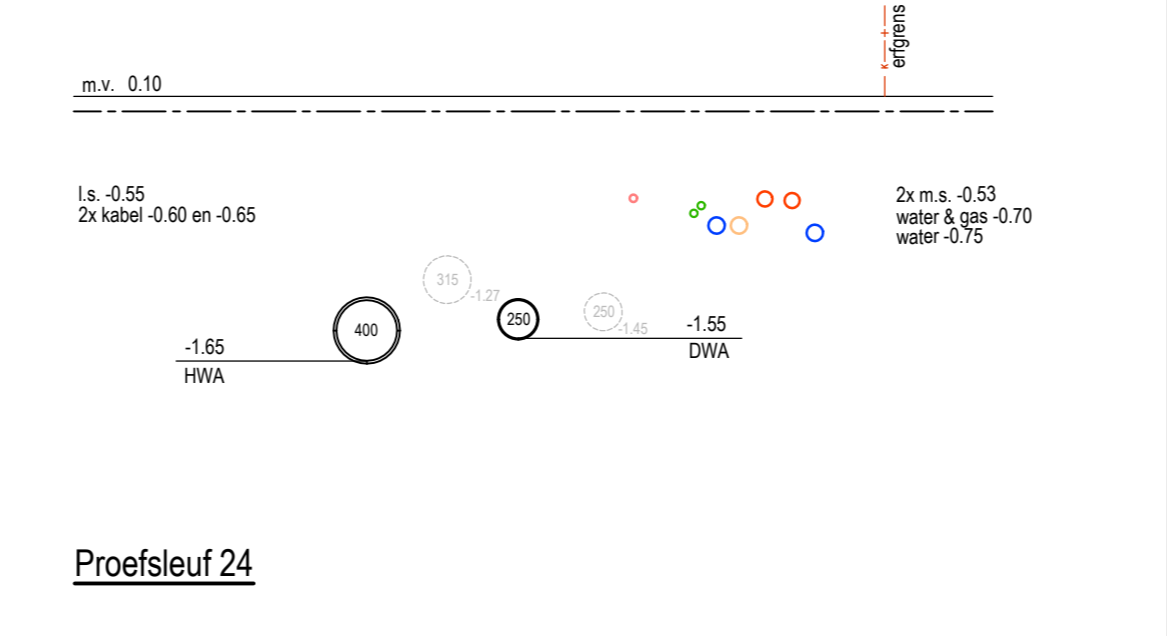

Proefsleuf 24

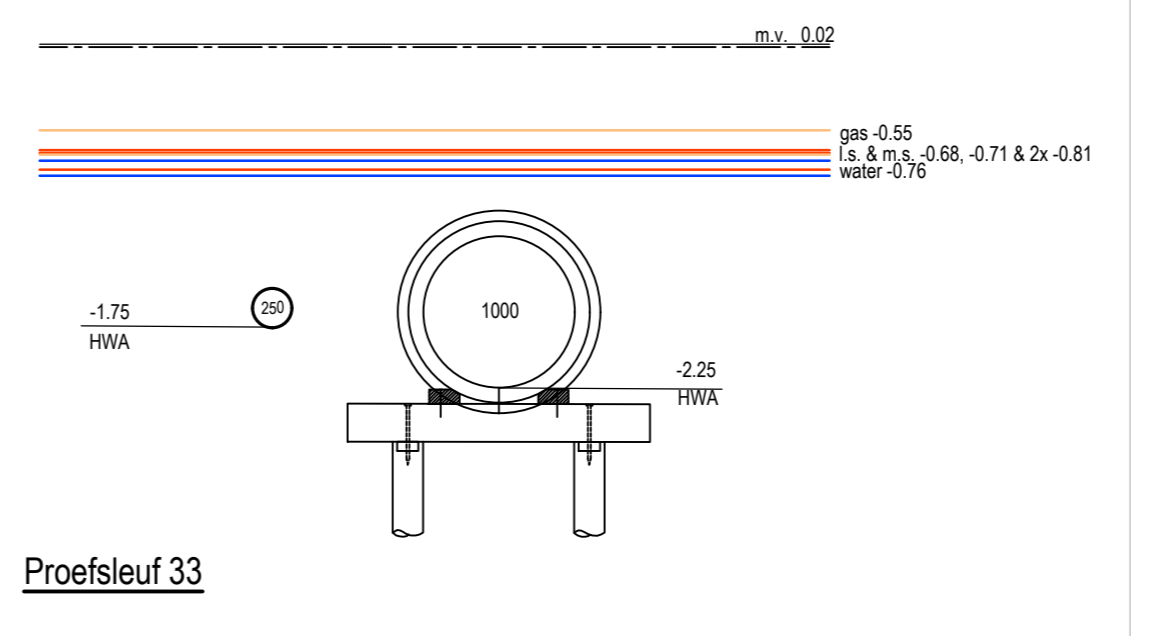

Proefsleuf 33

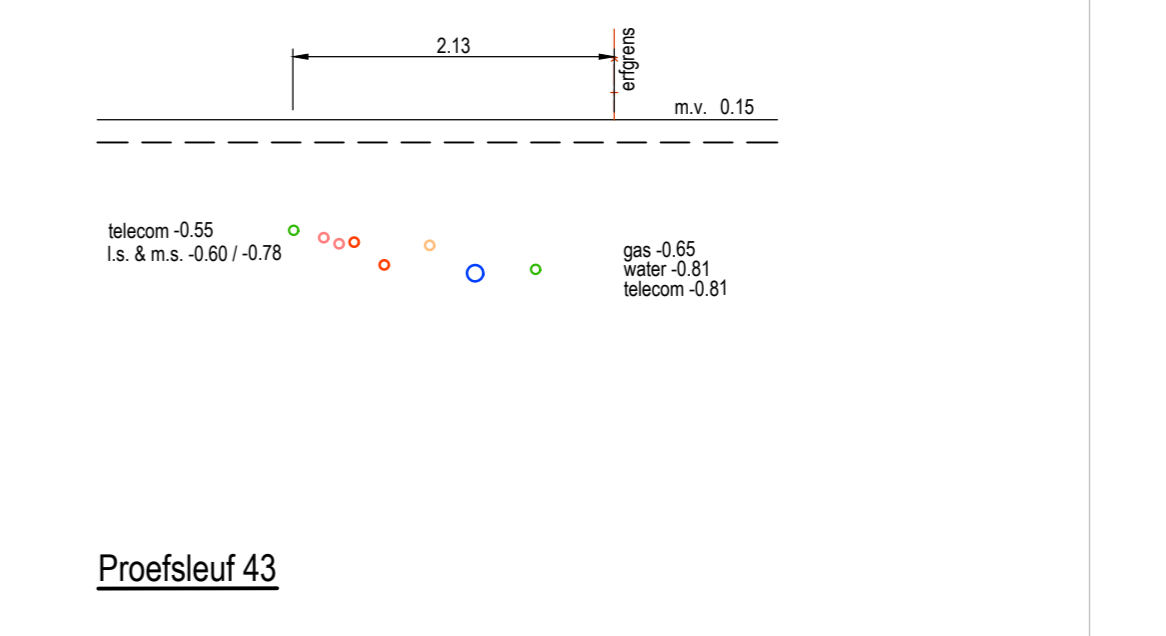

Proefsleuf 43

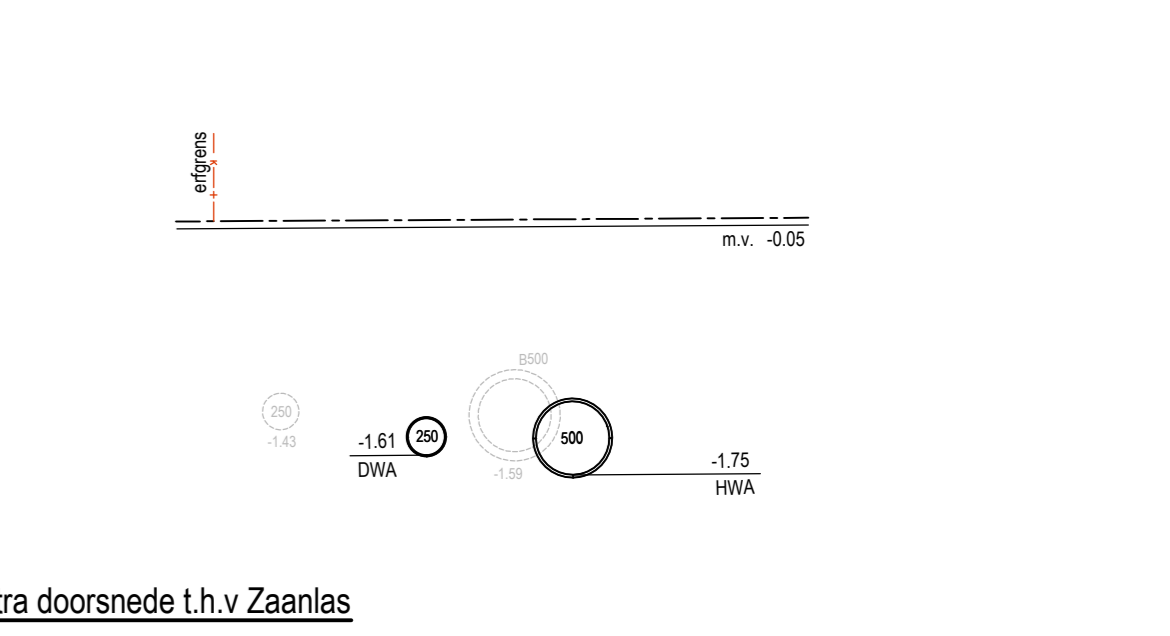

Extra doorsnede 1 h.v Zaanlaas

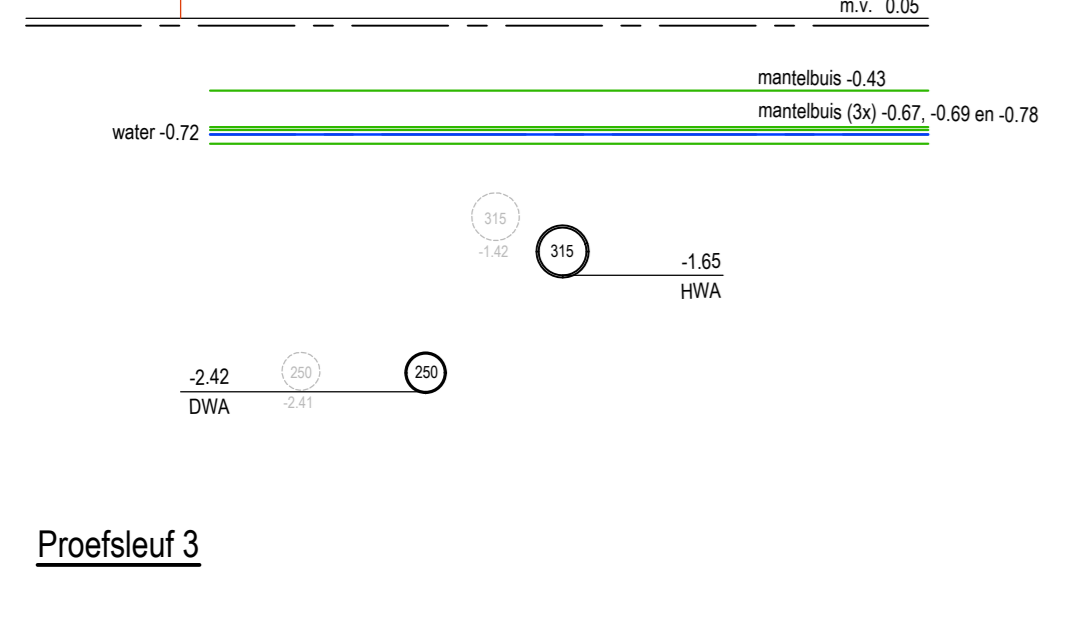

Proefsleuf 3

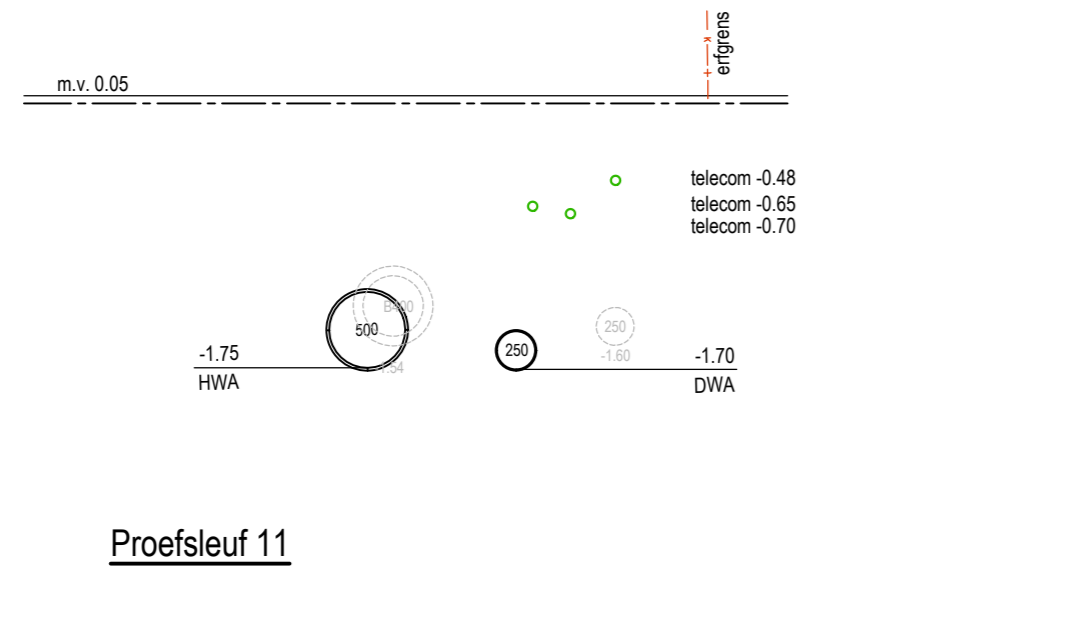

Proefsleuf 11

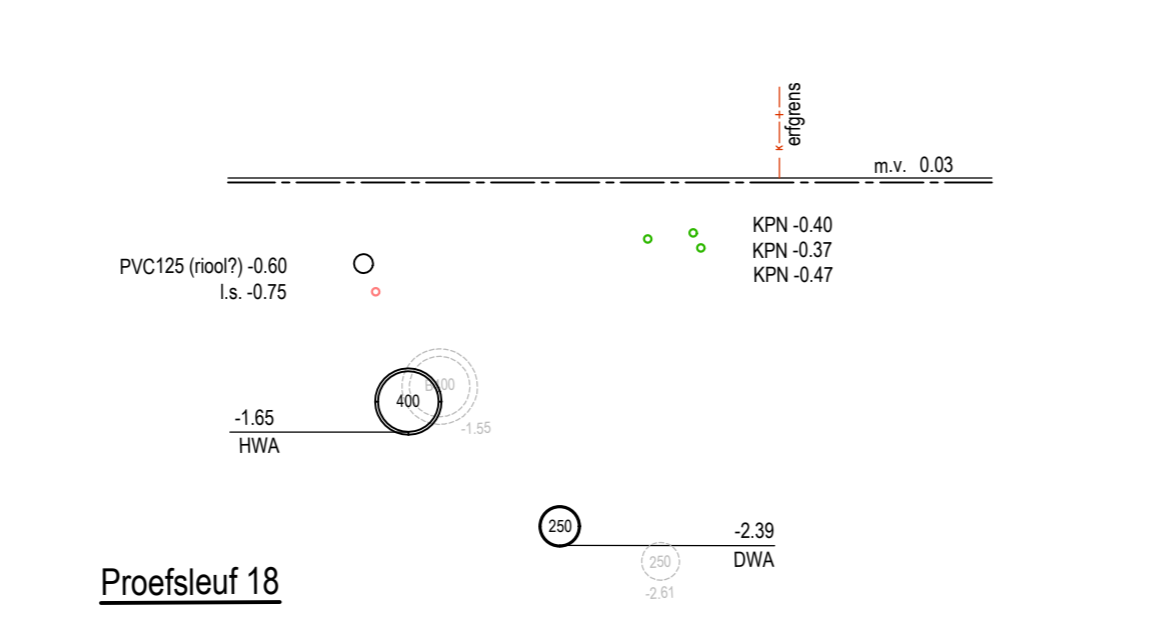

Proefsleuf 18

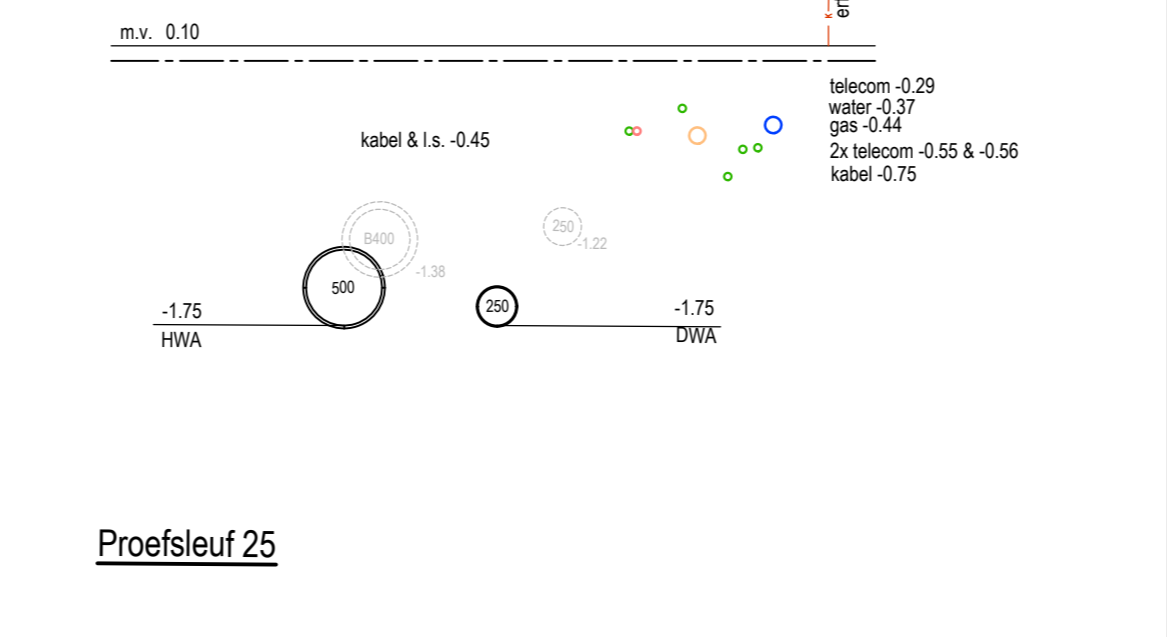

Proefsleuf 25

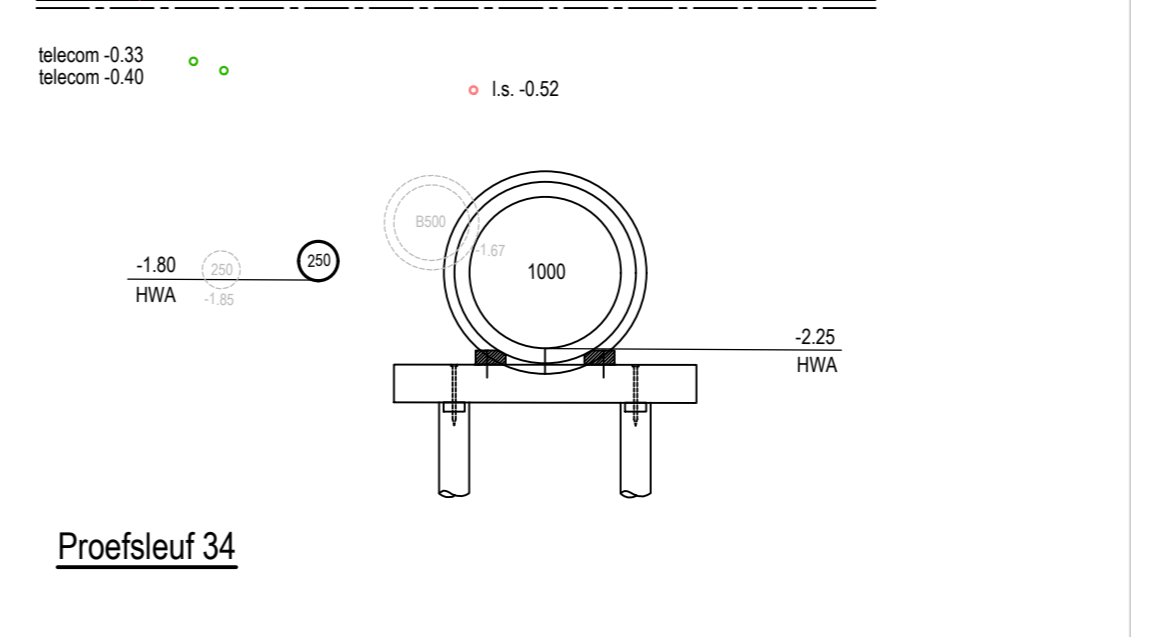

Proefsleuf 34

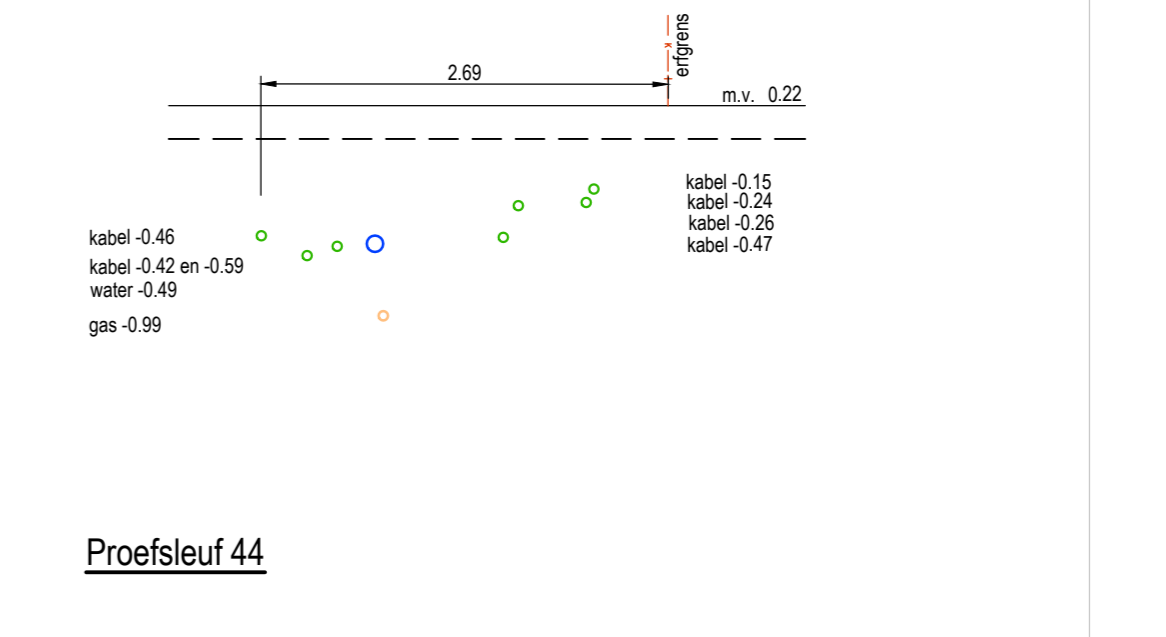

Proefsleuf 44

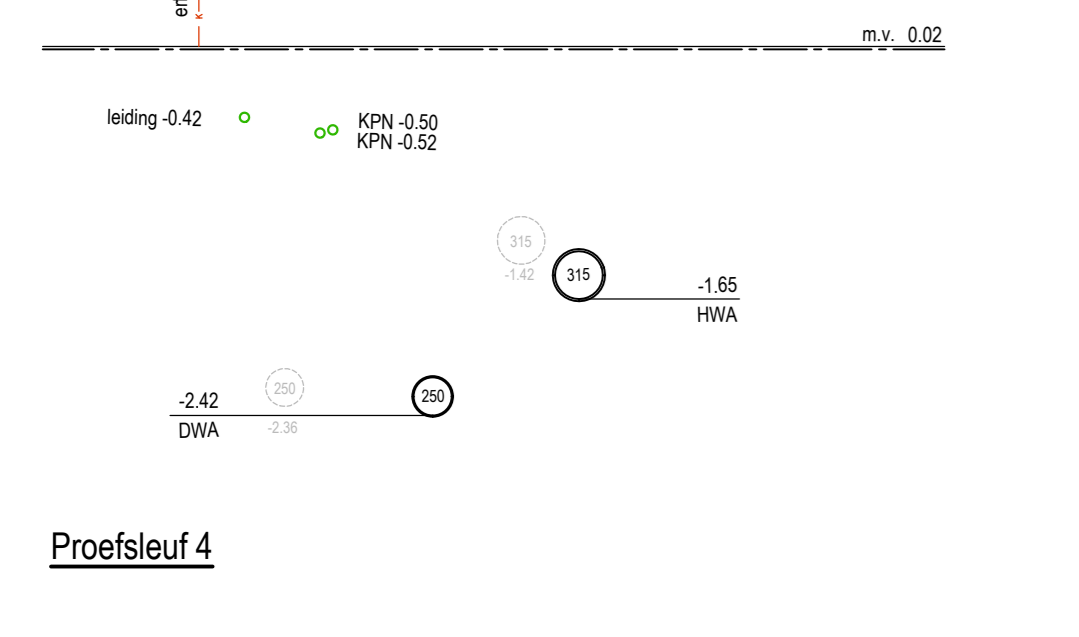

Proefsleuf 4

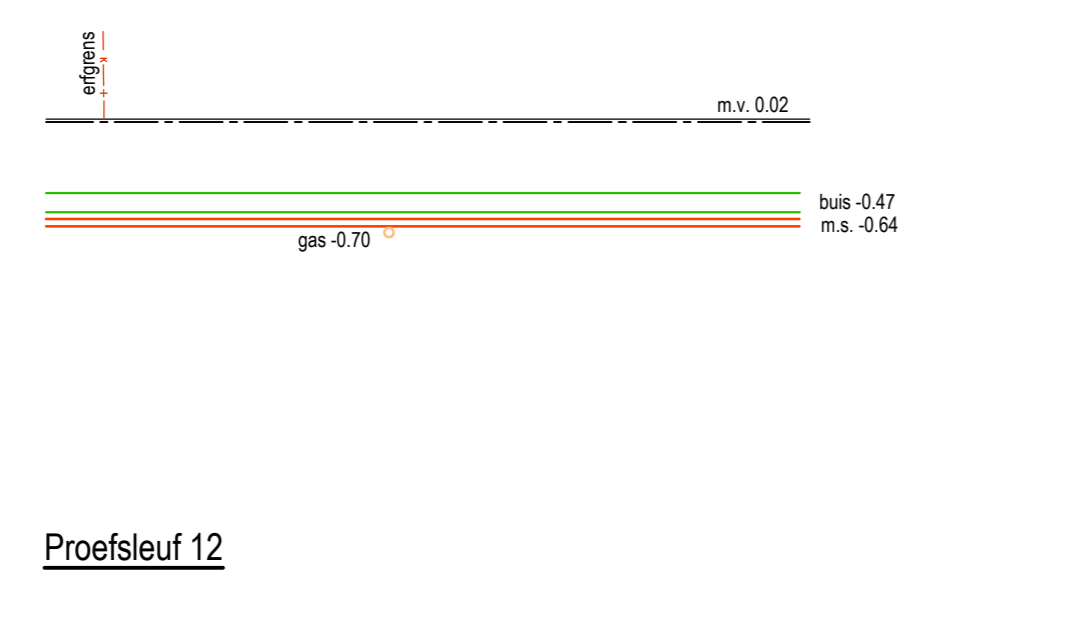

Proefsleuf 12

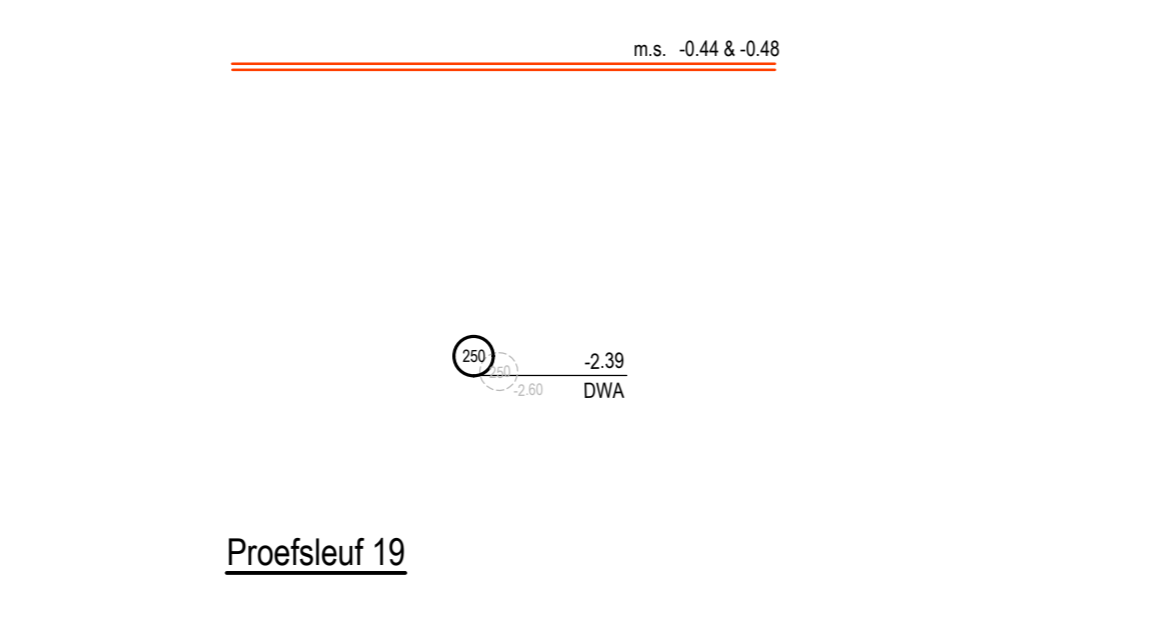

Proefsleuf 19

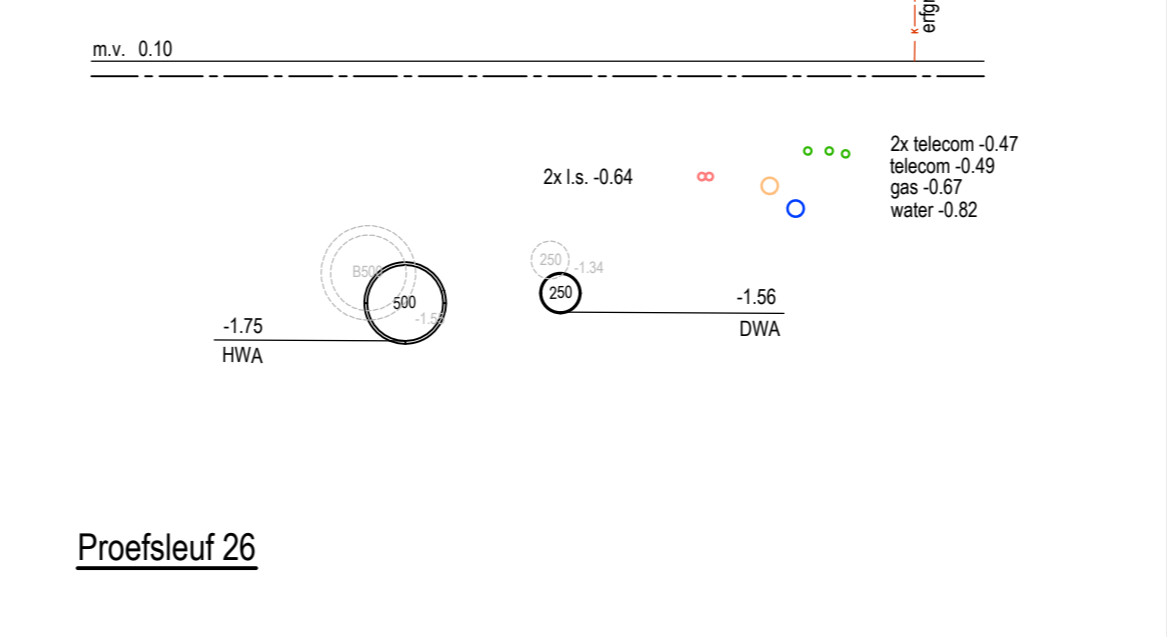

Proefsleuf 26

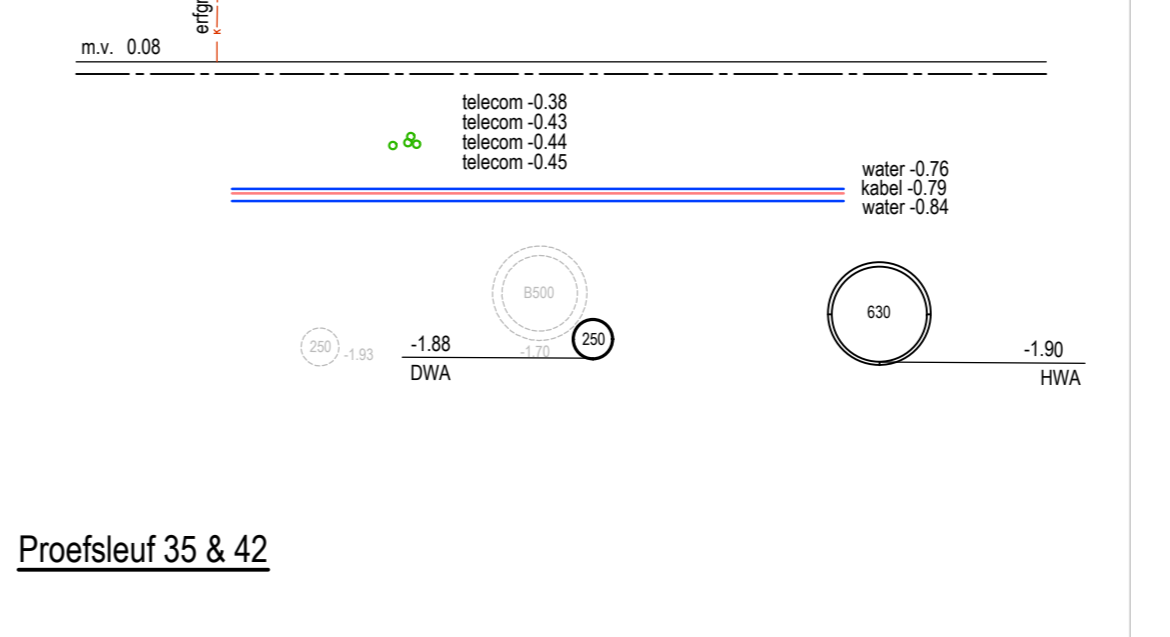

Proefsleuf 35 & 42

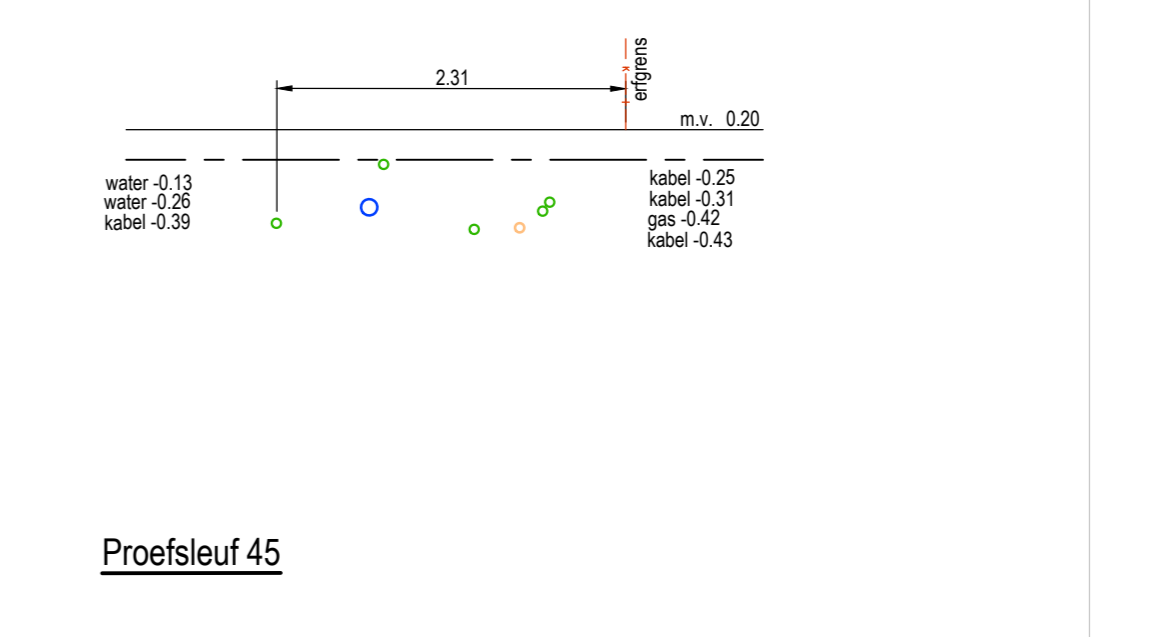

Proefsleuf 45

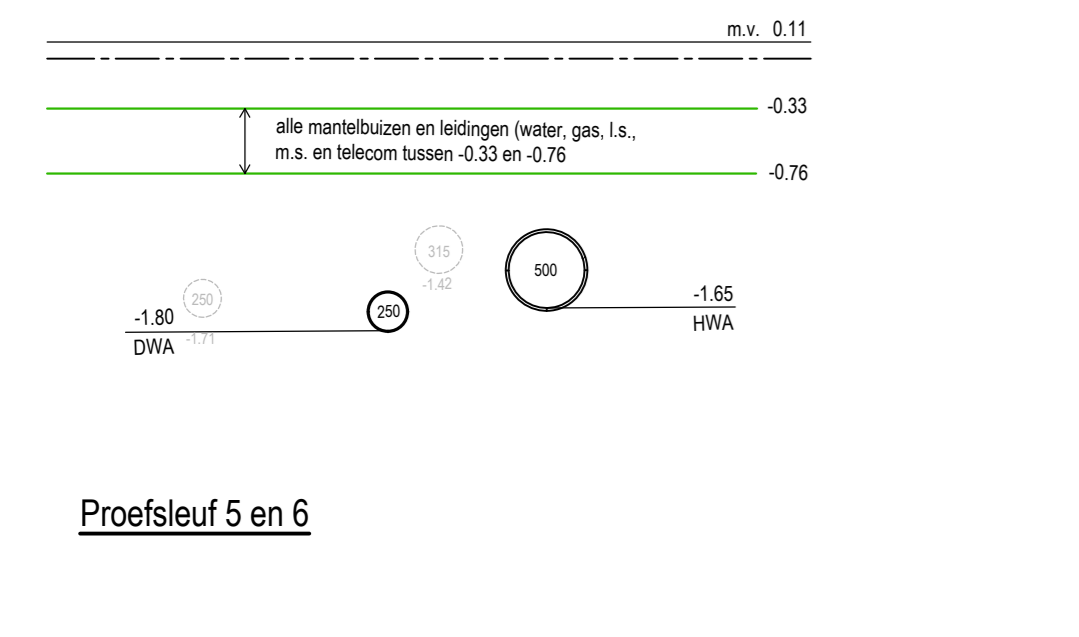

Proefsleuf 5 en 6

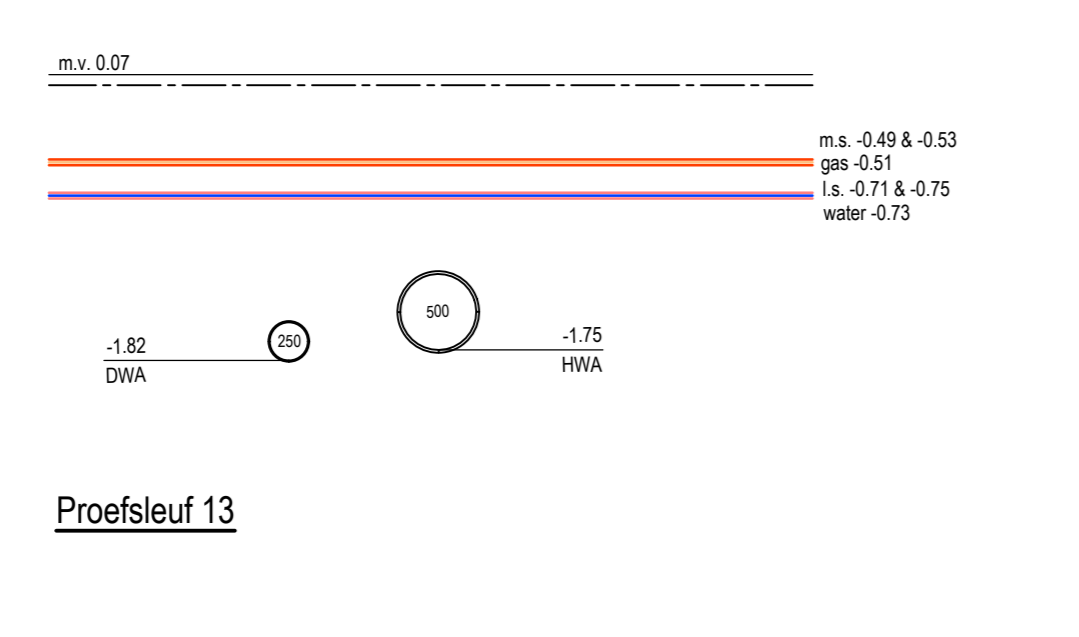

Proefsleuf 13

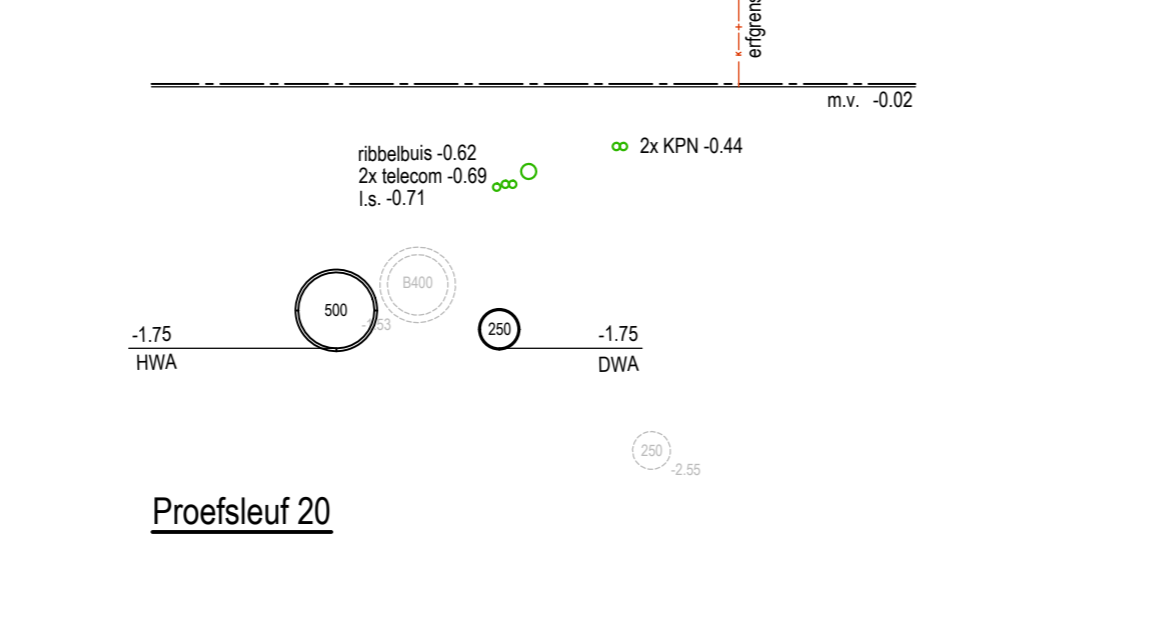

Proefsleuf 20

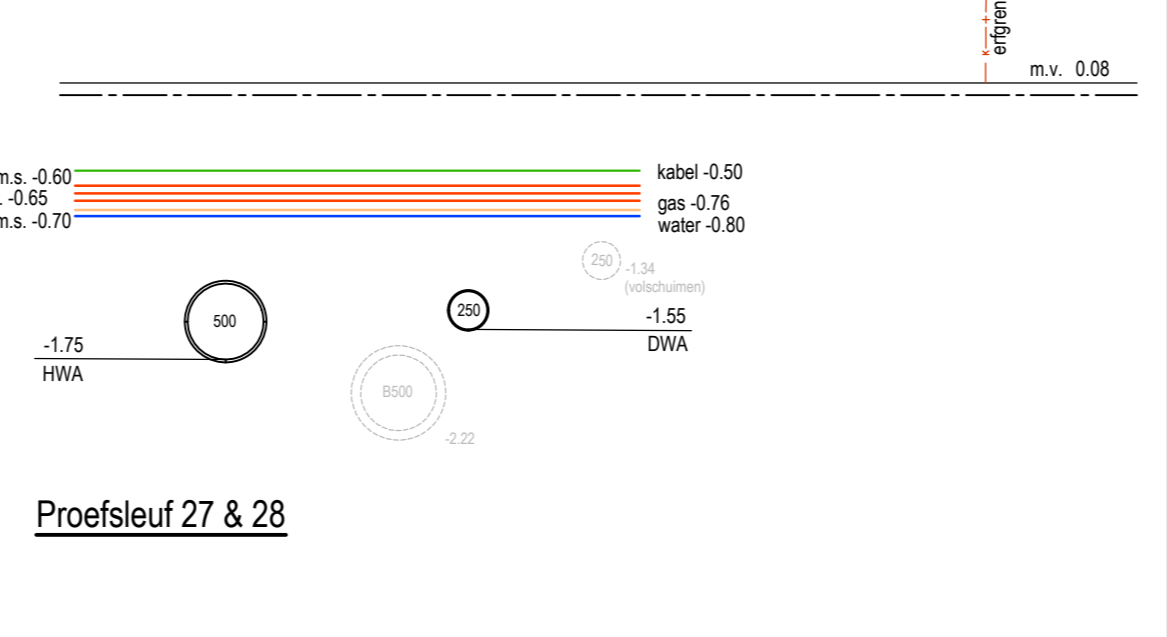

Proefsleuf 27 & 28

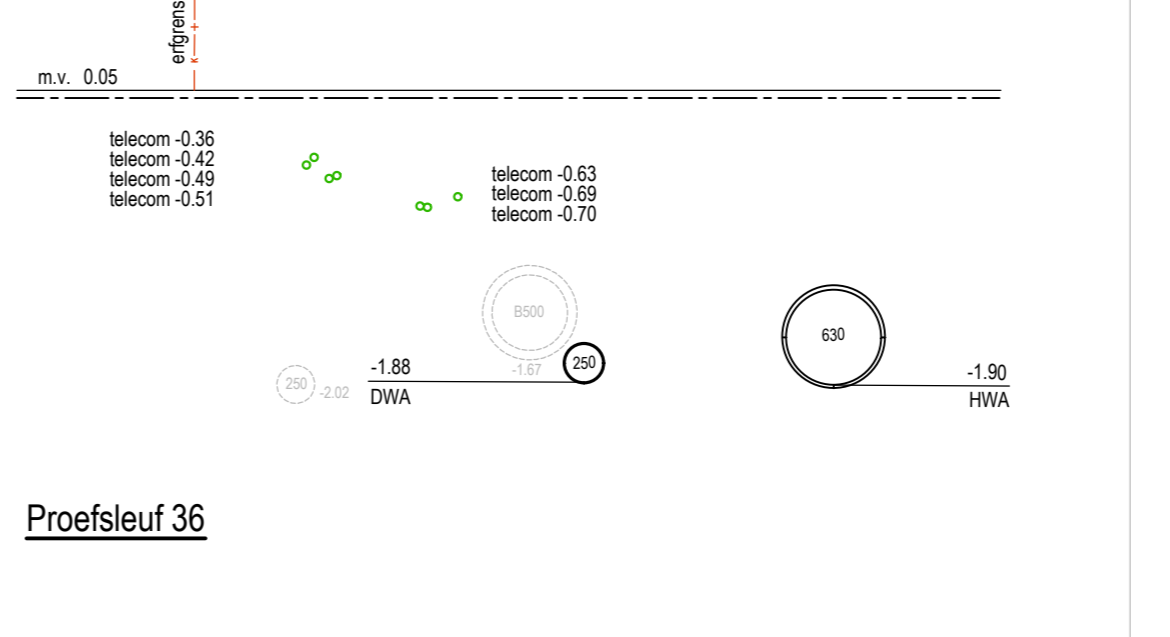

Proefsleuf 36

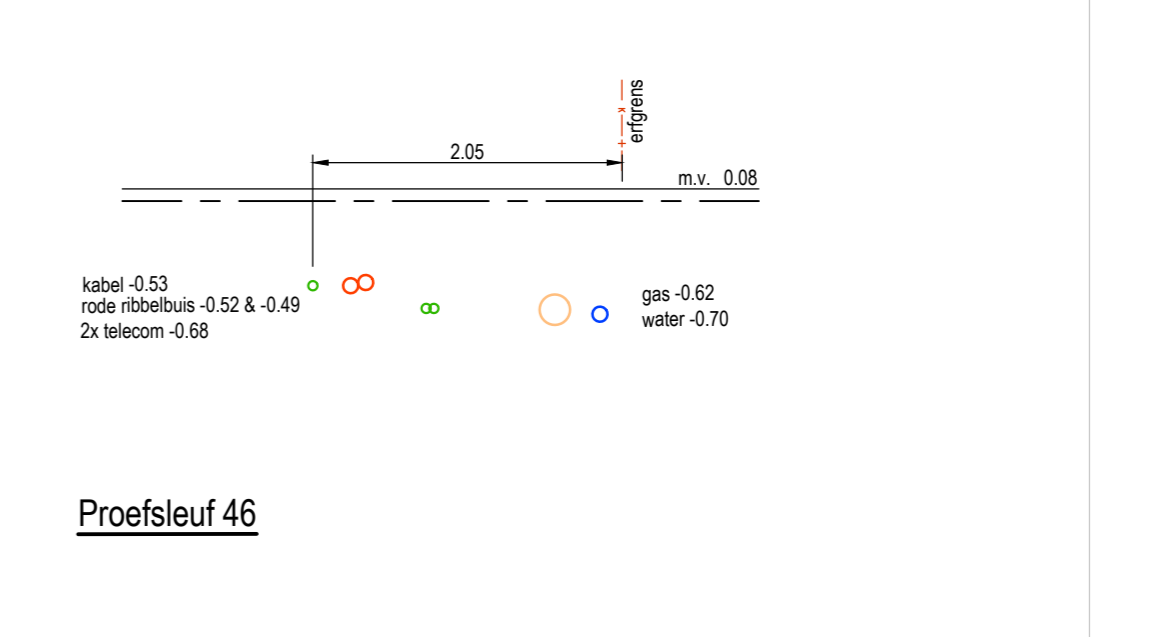

Proefsleuf 46

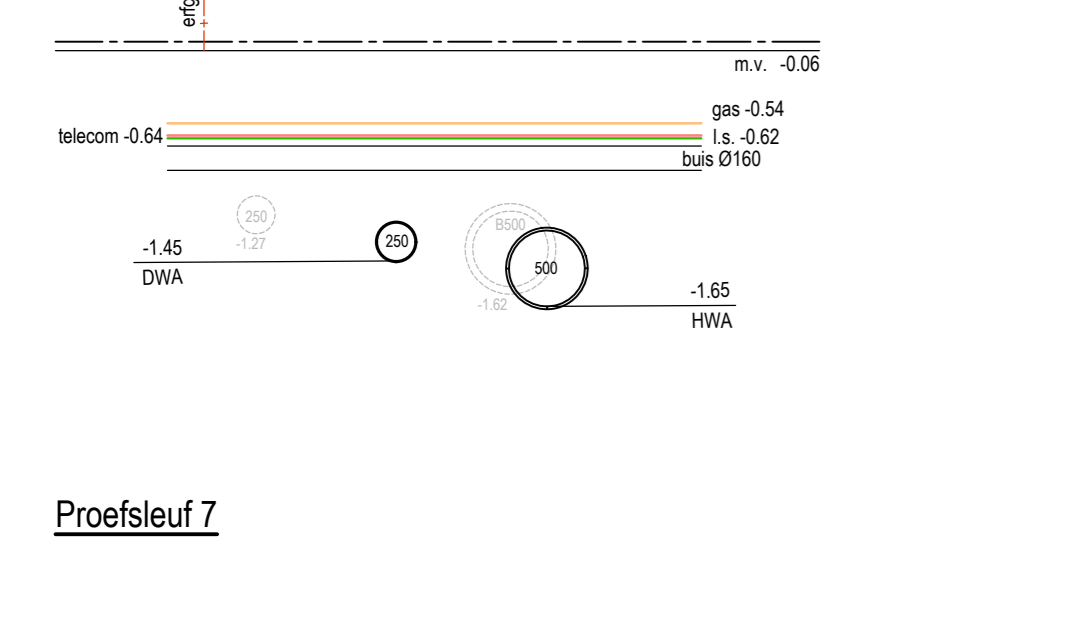

Proefsleuf 7

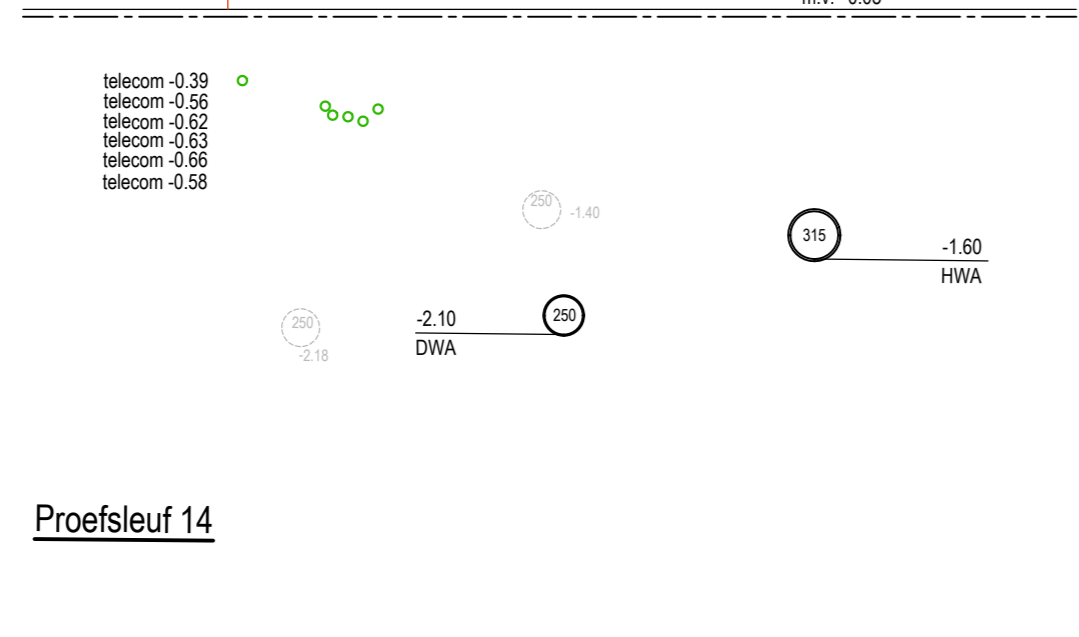

Proefsleuf 14

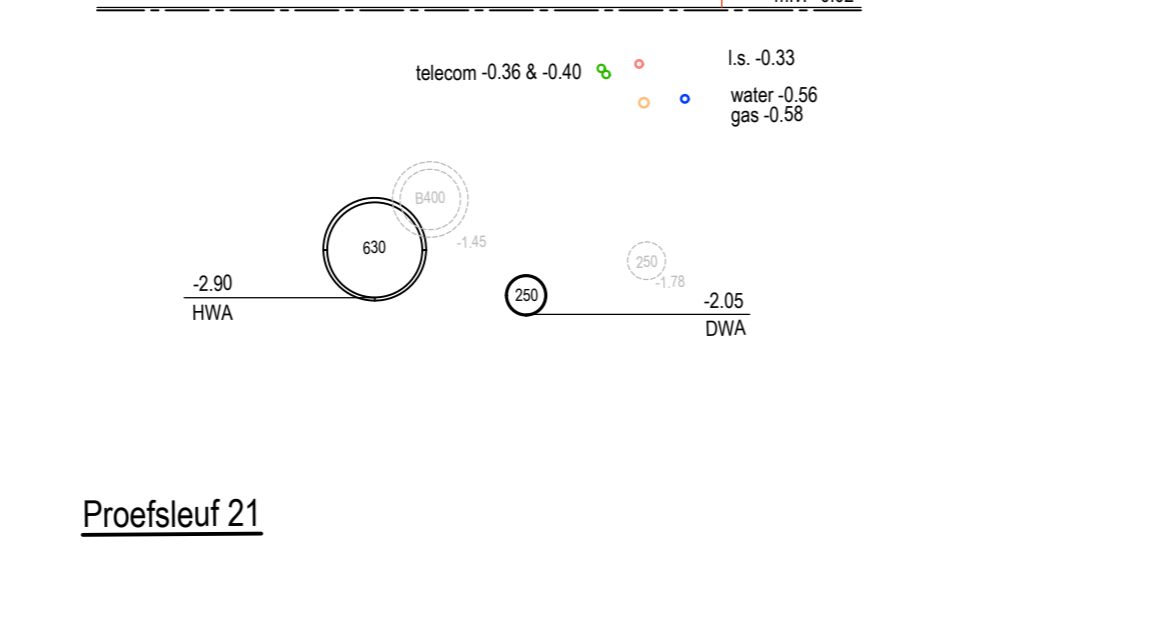

Proefsleuf 21

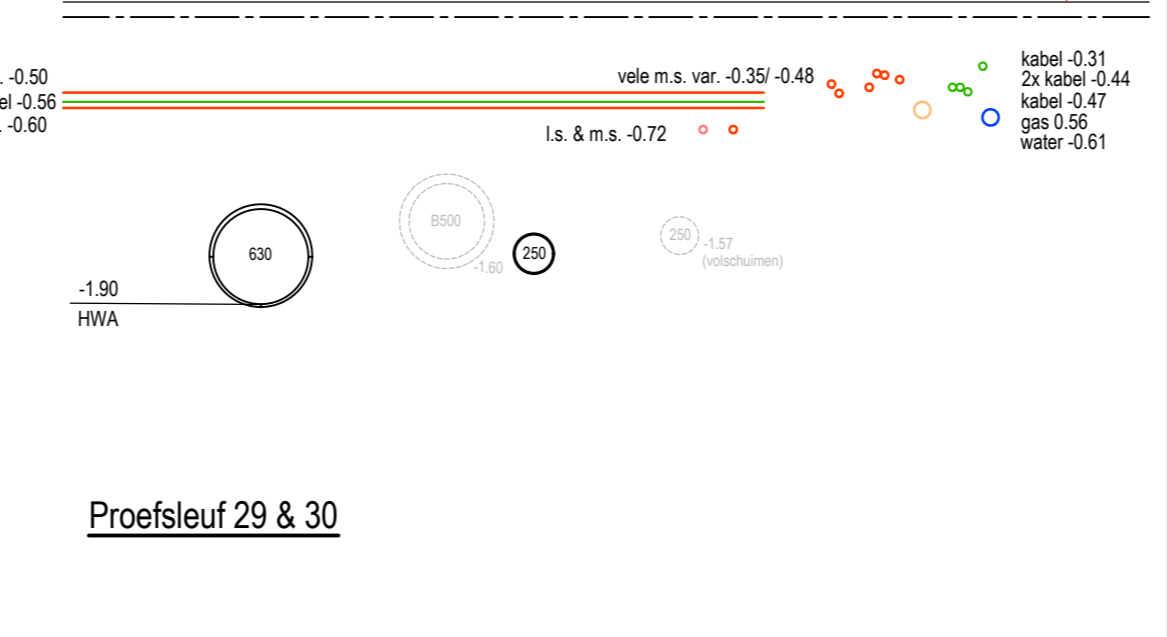

Proefsleuf 29 & 30

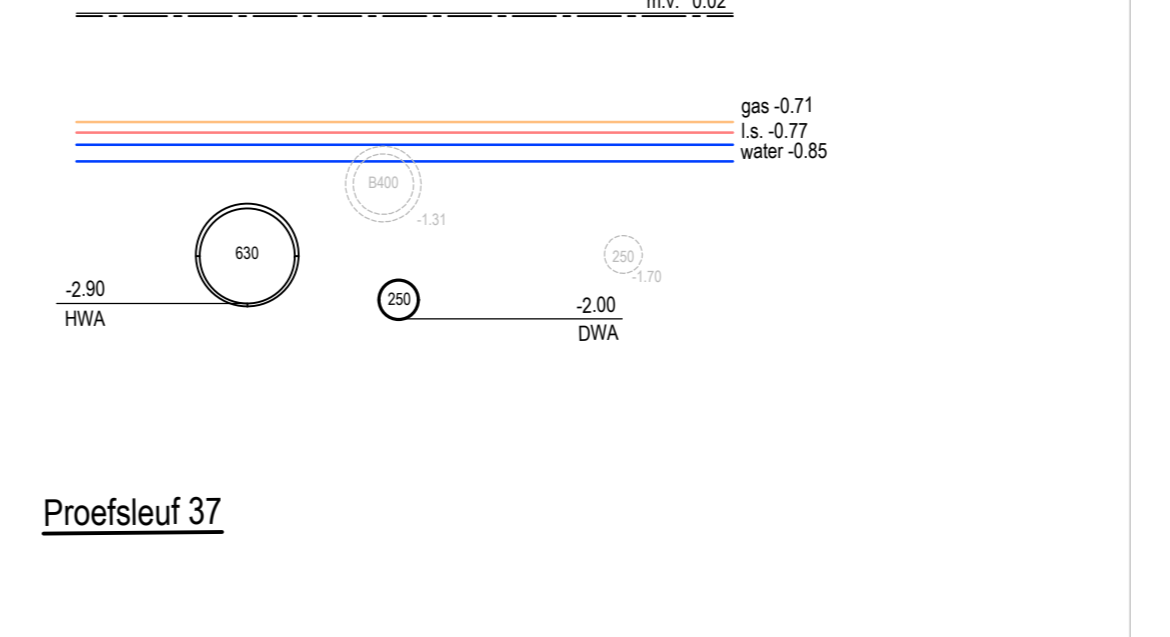

Proefsleuf 37

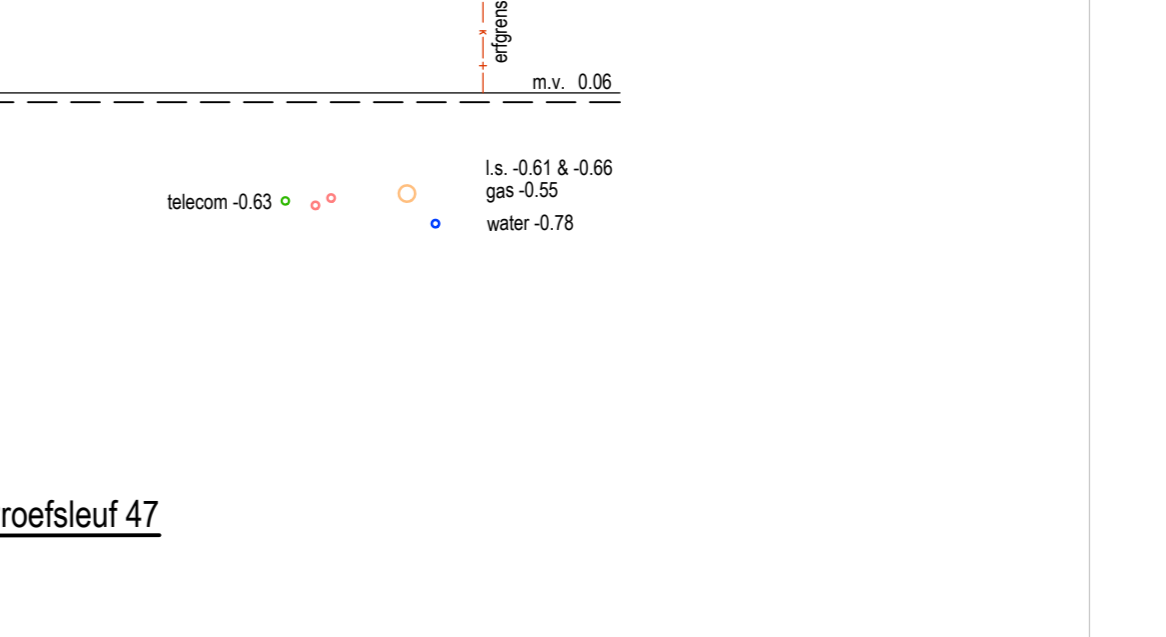

Proefsleuf 47

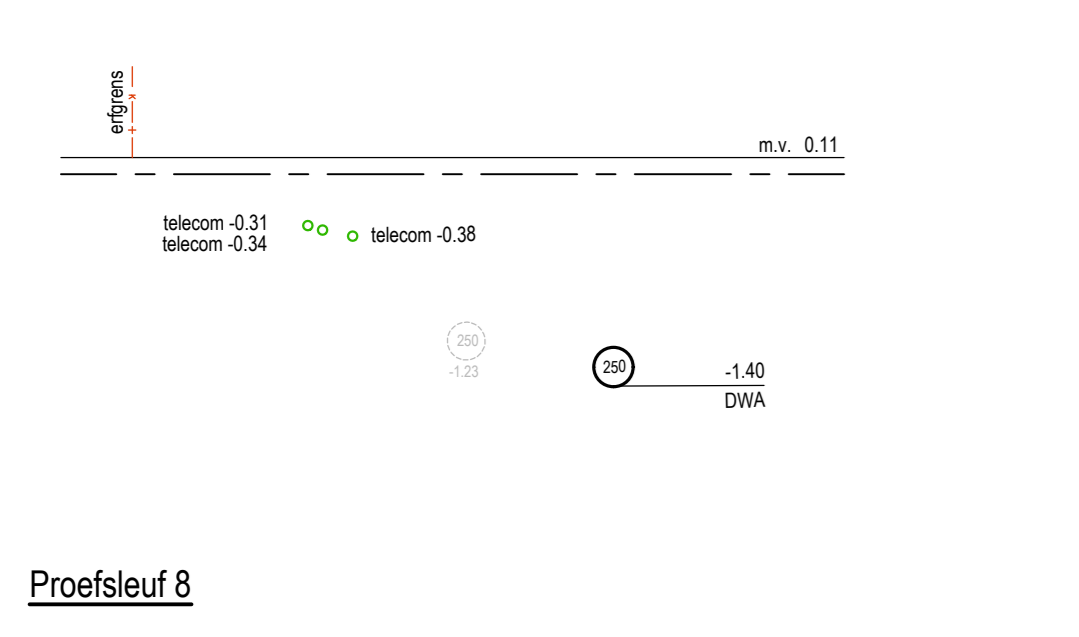

Proefsleuf 8

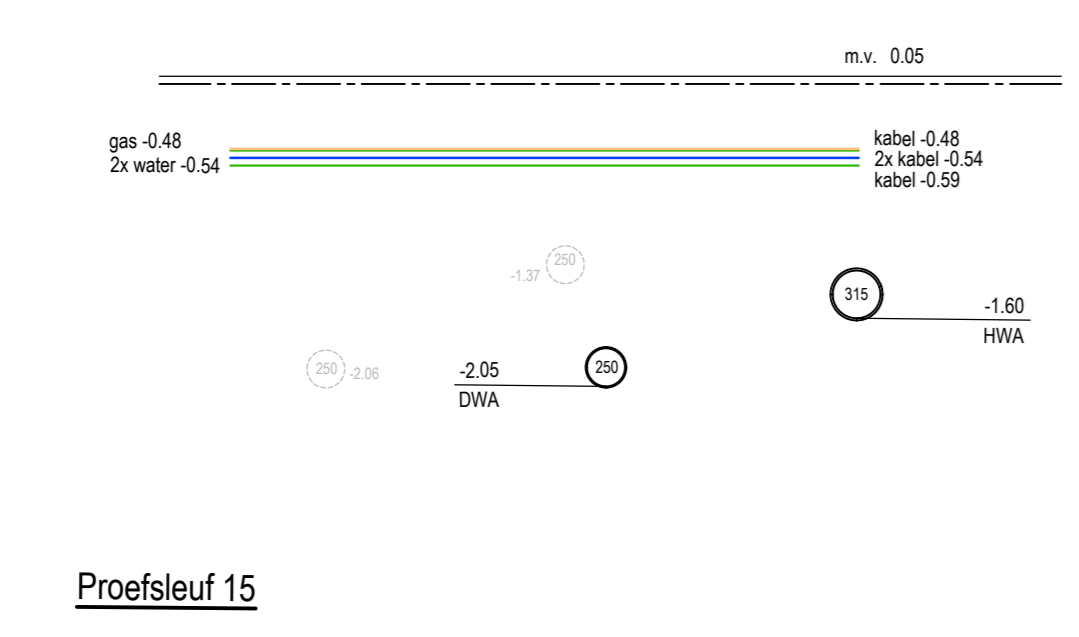

Proefsleuf 15

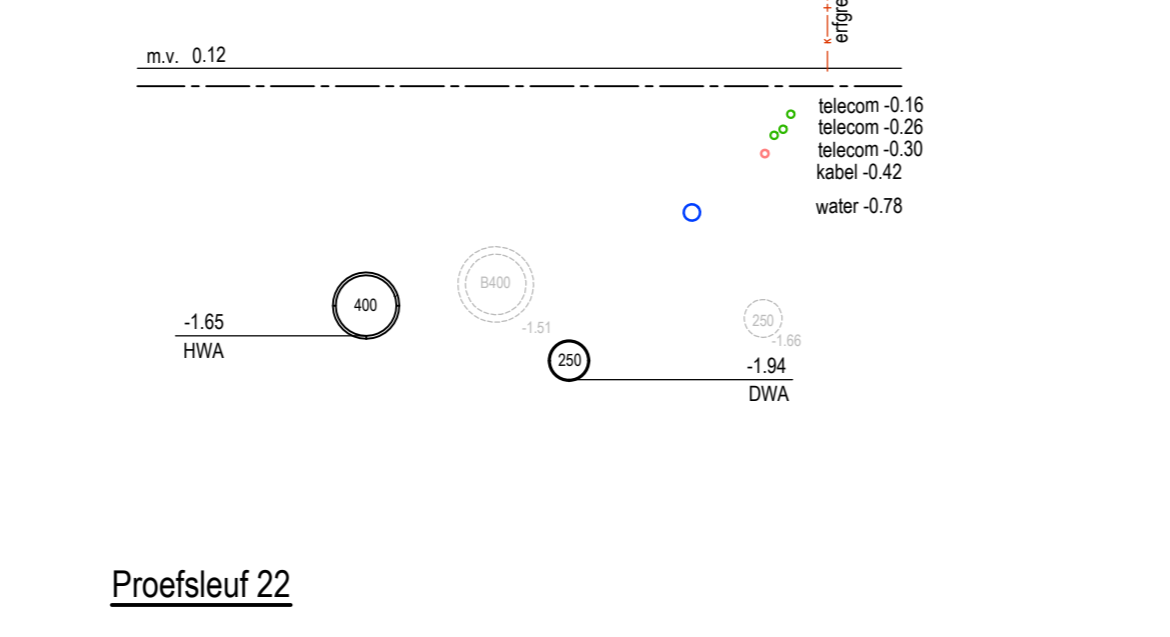

Proefsleuf 22

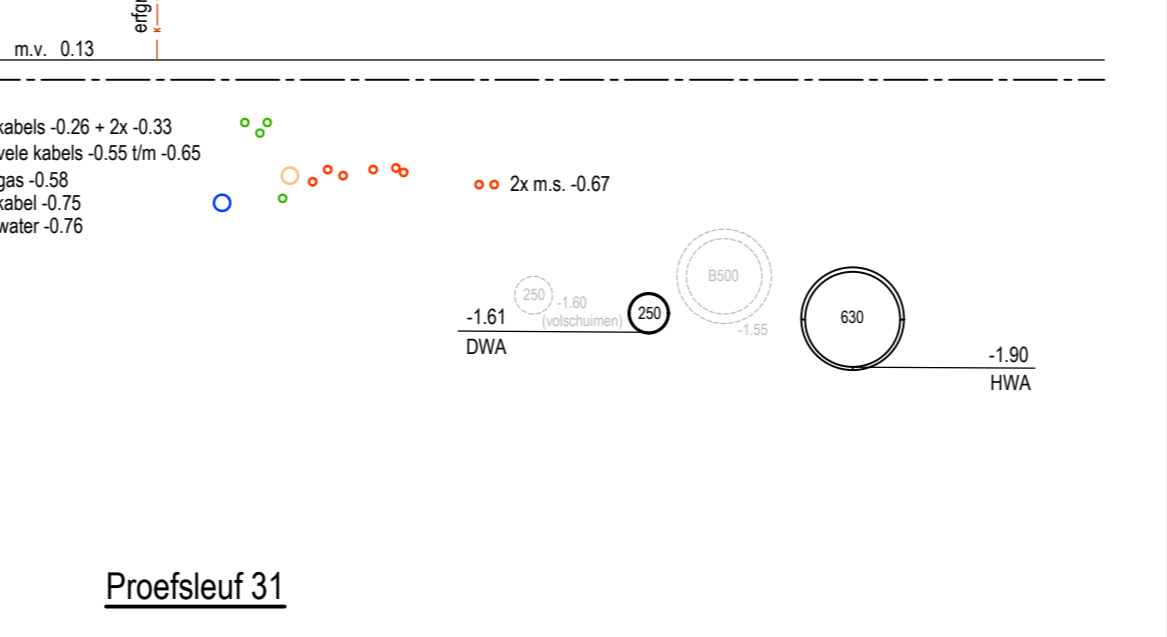

Proefsleuf 31

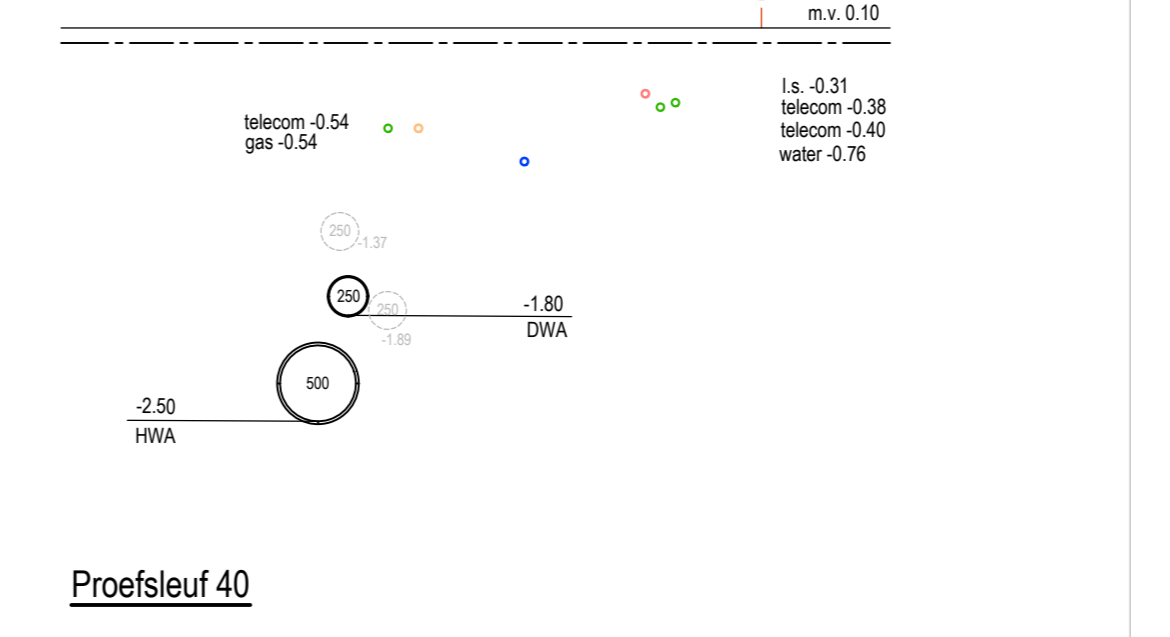

Proefsleuf 40

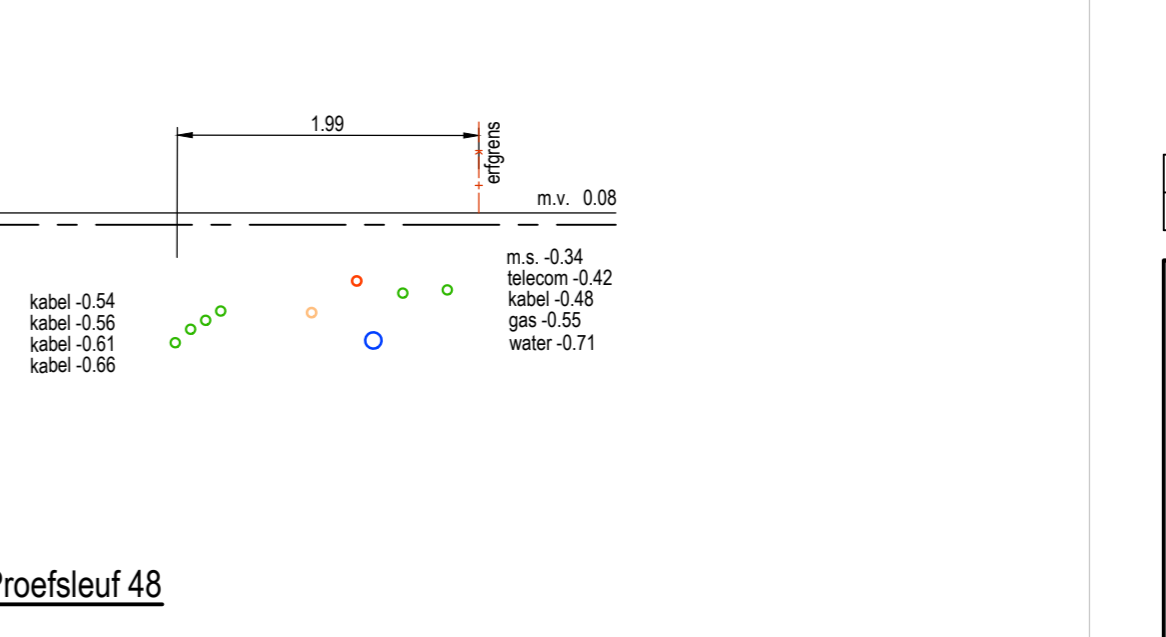

Proefsleuf 48

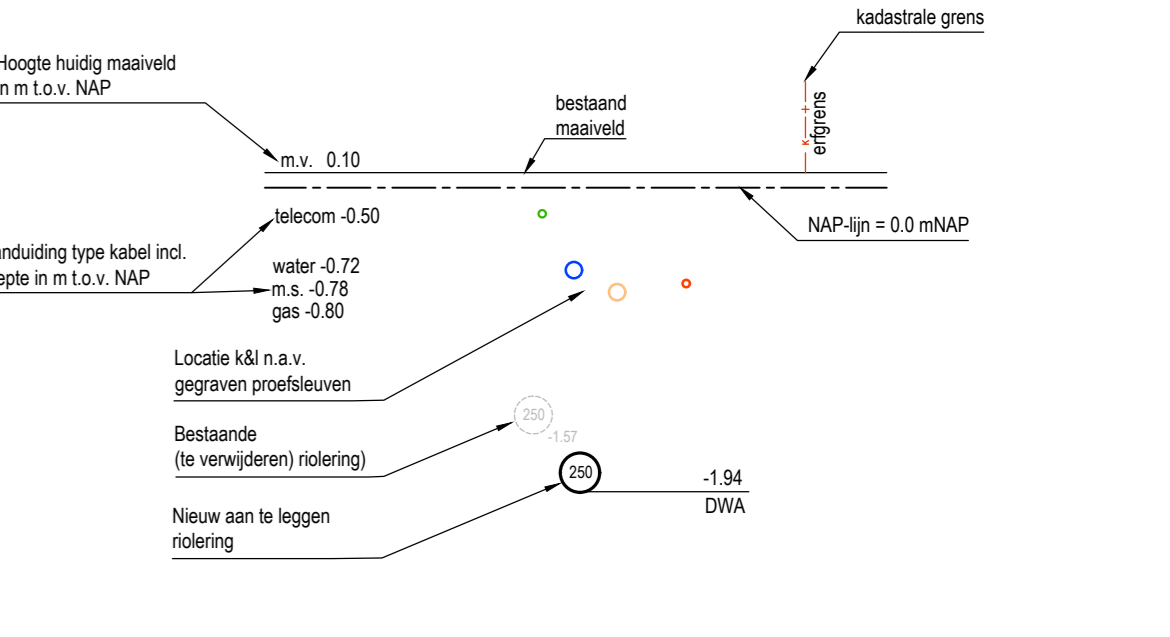

Beschrijving proefsleuf

WIJZ	DATUM	OMSCHRIJVING	TEKENAAR
PROEFSLEUF	10/12/20	Heinriching en vervangen riolering Grote Tocht e.o.	J. Veenboer
ONDERWERP		Uitwerking proefsleuven	1000000000
TEKENINGNUMMER	WIJZING	BLAD	GENEENTE ZAANSTAD
Bijlage 5-2		1	gemeente Zaanstad
30-09-2021	SCHAAL	FORMAAT	1000000000
	1:50	A0	1000000000

